



!DEA.

SIMPLY...UNIQUE

Unical

Pure technology



Clean design and practical panel board with wide "Power save" display

The idea of !DEA was born from three concepts:

- *Maximum easiness of use*
- *Extreme reliability*
- *Highest installation speed*

The range consists of **18 wall hung gas** boilers (13 for indoor installation and 5 for outdoor installation) for heating only or for heating and D.H.W. production, both, in *room sealed* or *natural draught* versions, with electronic ignition and conventional combustion.

!DEA can operate with natural gas or LPG.

Electrical protection degree is IPX5D (IPX4D for natural draught version).

It has been conceived both, for the first installation and for replacement of existing boilers in a very simple way.

Thanks to the electronics, developed together with Honeywell, and to the rationalization of the assembly, that make it unique, impresses for the maintenance simplicity and for its sturdiness.



































































































Elements that reinforce this imagine:

- *completely metallic casing*
- *epoxy-polyester painting*
- *sound and thermal insulation with 8 mm thick material*
- *thermal reflecting layer*
- *completely metallic hydraulic connections*

The aesthetics of the front panel has simple, engraved, curved lines, that confer great solidity to the whole assembly and integrate pleasantly the panel board, including:

- two knobs
- a time-controlled back lighted display for the maximum electric saving
- boiler pressure gauge

!DEA disposes of a complete catalogue of accessories, smoke pipes, modulating or ON/OFF thermostats, outer sensor, allowing to solve any installation problem.

MODELS FOR:	INDOOR installation								OUTDOOR installation	
TYPE			natural draught	room sealed fan assisted	bithermal heat exchanger	mono thermal heat exchanger	electric diverting valve	DHW plates heat exchanger	on wall	in cabinet
!DEA AR 23										
!DEA RS 18-24-28										
 !DEA AC 23										
!DEA CS 18-24-28-32										
!DEA AC 23 Plus										
!DEA CS 24-28-32 Plus										
!DEA RS 24 Ext										
!DEA CS 24 Ext										
!DEA RS 24 Inc										
!DEA CS 24-28 Inc										

The mechatronics of !DEA



Bi-thermal copper heat exchanger for !DEA AC 23 and CS 18 - 24 - 28 - 32 with different lengths

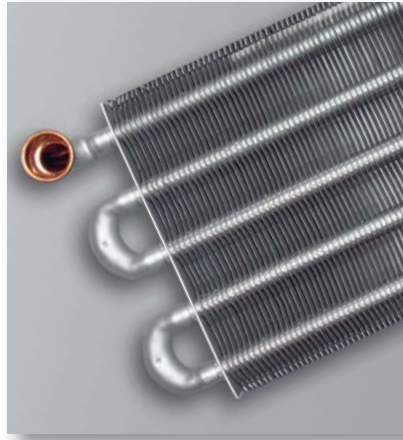

Mono-thermal copper heat exchanger for !DEA AR 23, RS 18 - 24 - 28, AC 23 Plus and CS Plus 24 - 28 - 32



Panel board with back lighted, multifunctional, "Power save" display



Pump body with built-in air vent

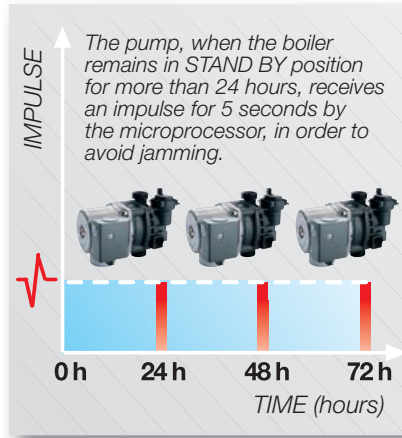

Pump anti-jamming function timer

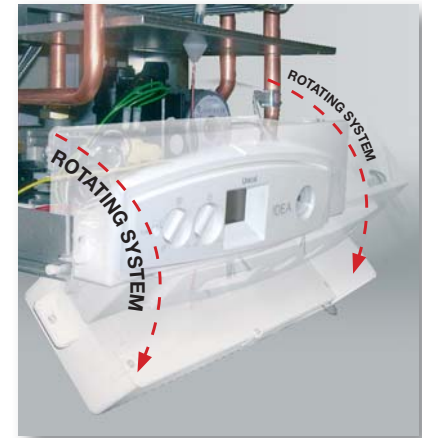

Frontward rotating panel board for an easy access to the internal components



HONEYWELL electronic PCB with microprocessor



Built-in flow switch



Anti-frost protection for high reliability

The components quality

The copper heat exchangers

Under the same casing are foreseen, according to the model, **different types of heat exchangers**, with fast connections, in order to speed up the maintenance, carefully studied.

■ **!IDEA AC 23 - !IDEA CS 18-24-28-32** **!IDEA CS 24 Ext - !IDEA CS 24 -28 Inc**

Bi-thermal ultracompact heat exchanger, with a large finned surface made of six copper pipes of oval section, where inside are inserted the pipes for sanitary water circulation (up to 17,83 l/min) with a temperature difference between inlet and outlet of 25K, assures the maximum rapid heat exchange.

- Combustion efficiency up to 94,4% at full load.
- High combustion quality with CO₂ up to 8.5% and CO at 58 ppm.
- Effective air venting thanks to the oversized manifolds, that assure an easy water circulation and a remarkable noise reduction thanks to the reduced internal pressure losses.
- Maximum thermal exchange speed due to the large number of exchange fins.
- Drastic reduction of the scaling deposits.
- Fast hydraulic connections.
- Immediate hot water production if compared to the traditional instantaneous boilers.
- Quick answer to the temperature variations, thanks to the very low inertia as result of materials and shape.
- Sensible energy saving.

■ **!IDEA AR 23 / RS 18-24-28 / AC 23 Plus / CS 24-28-32 Plus** **!IDEA RS 24 Ext - !IDEA RS 24 Inc**

Mono thermal ultra-compact heat exchanger with finned surface that winds six oval-shaped copper pipes.

- Combustion efficiency of 94,6% at full load.
- High combustion quality with CO₂ up to 8.4% and CO at 60 ppm.
- Fast hydraulic connections.



Bi-thermal copper heat exchanger

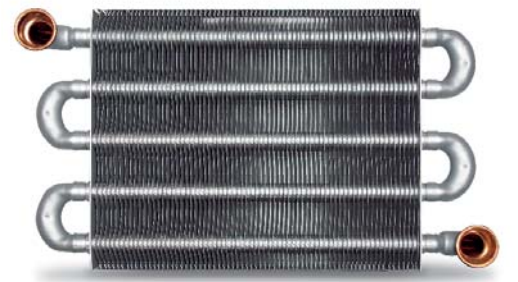

Mono thermal copper heat exchanger

The high comfort combi

■ **DHW stainless steel plate heat exchanger** (n°12 plates for 23 and 24 kW - n°14 for 28 kW n°16 for 32 kW)

This choice gives an higher exchange surface, so, with the same water temperature and needed quantities, it's possible to let the boiler work with lower temperatures, obtaining:

- Constant water temperature during the drawings
- DHW production up to 18,47 l/min with Δt 25 K.

■ **Monothermic primary heat exchanger** (for AC 23 Plus and CS Plus 24-28-32):

it guarantees all the necessary capacity and the ideal efficiency at all load conditions.

- **Motorized diverting valve** (for all Plus models), of new conception, result of Unical technologic study, its part of a brass hydraulic group, very compact and, thanks to the powerful electric motor, allows quickly and safely to divert the hot water produced by the primary heat exchanger, to the plate heat exchanger or in loop to the heating circuit, optimizing the operation in temperature modulation.



Technology for the comfort

Supplied as standard for all the range

The design has particularly cured the internal positioning of all the components together with the search of the best compromise between compactness and ease of maintenance.

- **The wide burner in stainless steel**
with 11 ramps (for 18 - 23 and 24 kW), 13 ramps (for 28 kW) and 15 ramps (for 32 kW) produces a silent and well distributed combustion.
- **The digital electronic ignition**
with three flame ignition attempts, exalts its reliability in every climatic condition, both "at cold and hot start".
- **The continuous proportional/integral modulation of the gas** managed by the HONEYWELL driving PCB, both in CH and DHW mode, through two temperature control sensors (for DHW and CH), determines, with a precision close to 1 K, the certitude of the pre-set adjustments.

High performances

- **Highly effective pump**
among the most reliable ones, complete with fast removable air vent, has been selected to compose a redoubtable hydraulic group, suitable for all the models. At last, an assembly of electronic functions exalts the completeness of its performances.
- **The anti-overheating post-circulation**
of 15 seconds controls, in every condition, the thermal equilibrium between flow and return, also after strong drawings of DHW, whilst, in CH mode, with a lasting of 5 min, allows to exploit all the residual heat.
- **The anti-frost protection**
intervenes at 5°C and is activated both, in DHW and in CH mode, increasing the boiler temperature at 15°C. The risk that !DEA could freeze, if the low temperature, where the boiler is installed, persists, is avoided. If there is lack of gas, the lockout of the boiler will be shown on the display.
- **The pump anti-jamming function**
also after long inactivity periods, sends an impulse to the pump for 5 seconds, every 24 h stop, that makes the pump in operation, thus avoiding the oxidation could block it.
- **The technical service function**
makes easier the combustion adjustment operations. By depressing the reset button for more than 3 seconds, it is possible to obtain the boiler operation, at min. or max. output, for 15 min, so that the necessary gas valve adjustments can be made.
- **The air pressure switch**
has been selected in order not to be influenced by the external climatic conditions that could make its function fruitless.



Dimensions of the models for indoor installation:

- height: 700 mm
- width: 420 mm
- depth 255 mm
(345 mm for all 28 and 32 kW models)

The *on wall mounting* of the **outdoor installation** models have the same dimensions of the correspondent indoor models. The only difference, for the on wall mounting boilers on the outdoor installations is the addition of a special rubber top to protect the boiler from the rain.

The cabinet for the *in cabinet mounting models (Inc)* have the following **dimensions**:

- height 1140 mm
- width 550 mm
- depth 260 mm

The model !DEA CS 28 Inc is less deep than the correspondent indoor model because the expansion vessel is placed beside, instead of behind the boiler, within the cabinet.

Intuitive controls

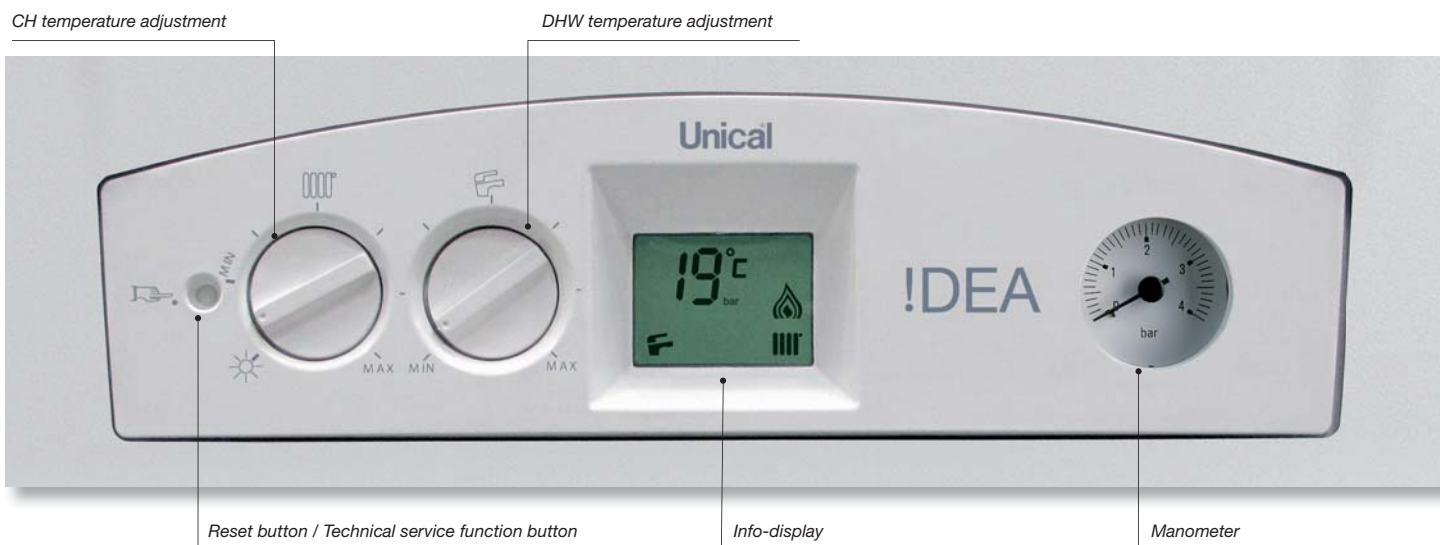

Panel board

The electronic panel board will result familiar immediately. And last, but not least, all the harness and intervention operations are easily made by the forward rotation of the panel board.

The multifunction LCD display, with time controlled back lighting, allows:

- The reading of the CH and DHW temperatures
- The showing of the burner lockout due to lack of flame
- The operation/stand-by status
- The diagnostics with indication of 11 possible faults
- L.H. side knob with double function: ON-OFF switch and CH temperature setting between 45 and 78°C
- R.H. side knob with DHW temperature setting between 35 and 57°C

Accessories (optional)



REMOTE CONTROL
REGOLAFACILE
modulating, weekly
Code 00260878



ON-OFF
CHRONOTHERMOSTAT
REGOLAFACILE
Code 00262605



CHRONOTHERMOSTAT
GA 240
Code 00260737



REMOTE CONTROL
SIM-PLEX
controls without
chronothermostat
Code 00262077



REMOTE CONTROL
SIM-CRONO
modulating, weekly
Code 00262079



**OUTER TEMPERATURE
SENSOR**
Code 00362077

Dimensions - Technical data

INDOOR INSTALLATION

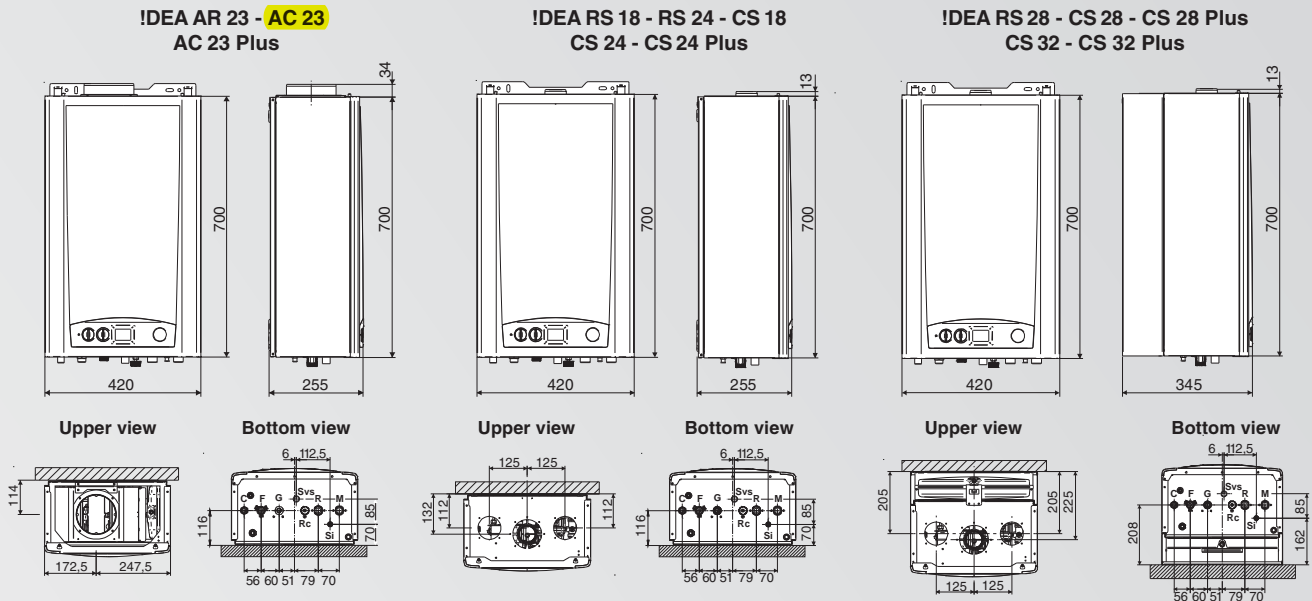

OUTDOOR INSTALLATION

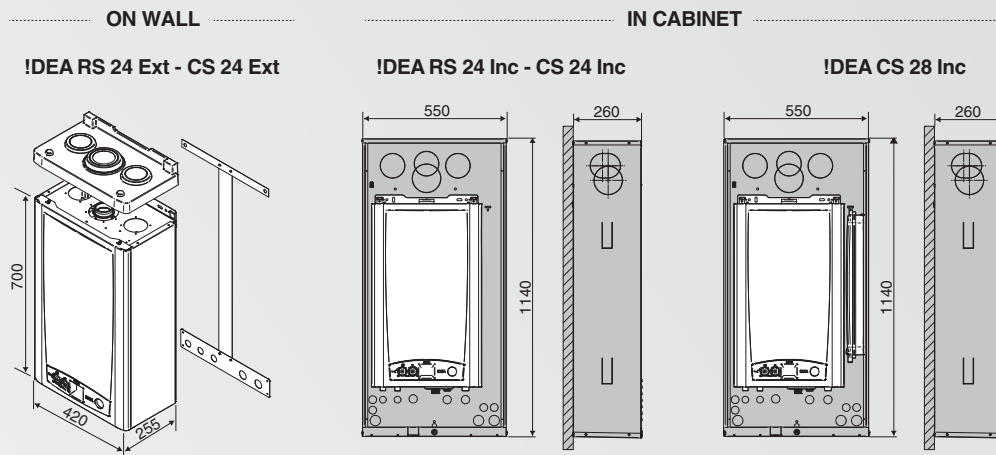

- C DHW outlet Rp 1/2
- G Gas inlet Rp 3/4
- F Cold water inlet Rp 1/2
- M CH flow Rp 3/4
- R CH return Rp 3/4
- Rc Filling cock
- Sc Boiler drain
- Svs Safety valve drain connection

IDEA		AC23	AR23	CS18	RS18	CS24 CS 24 Ext CS 24 Inc	RS24 RS 24 Ext RS 24 Inc	CS28 CS 28 Inc	RS28	CS32	AC23 Plus	CS24 Plus	CS28 Plus	CS32 Plus
NOMINAL HEAT OUTPUT	kW	22.9	22.9	18.5	18.5	24.6	24.6	28	28	31.6	22.9	24.7	28.1	32.3
NOMINAL HEAT INPUT	kW	25.5	25.5	20.5	20.5	26.5	26.5	30.1	30.1	34.5	25.5	26.5	30.1	34.5
MINIMUM HEAT OUTPUT	kW	9.9	9.9	7.8	7.8	10.1	10.1	10.2	10.2	11.6	9.9	10.1	10.2	12.2
WATER EFFICIENCY at part load (30%)	%	89.43	89.43	90.23	90.23	90.23	90.23	90.42	90.42	90.42	89.43	90.43	90.42	90.42
WATER EFFICIENCY at full load (100%)	%	89.9	89.9	92.4	92.4	92.92	92.92	93.18	93.18	91.69	89.8	93.05	93.21	93.5
FLUE GAS TEMPERATURE $t_f - t_a$ max.	°C	107.5	107.5	121.5	121.5	109	109	103.5	103.5	120.9	95.5	119.3	96.3	101.4
EFFICIENCY CLASS (Directive 92/42/CE)		★★	★★	★★	★★	★★★	★★★★	★★★★	★★★★	★★	★★	★★★★	★★★★	★★★★
WATER PRESSURE IN CH CIRCUIT min./max.	bar	0.5÷3	0.5÷3	0.5÷3	0.5÷3	0.5÷3	0.5÷3	0.5÷3	0.5÷3	0.5÷3	0.5÷3	0.5÷3	0.5÷3	0.5÷3
WATER PRESSURE IN DHW CIRCUIT min./max.	bar	0.5÷6	-	0.5÷6	-	0.5÷6	-	0.5÷6	-	0.5÷6	0.5÷6	0.5÷6	0.5÷6	0.5÷6
D.H.W. production in continuous, with Δt 25K - mixed	l/min	14.1	-	10.11	-	13.7	-	16.1	-	17.83	14.1	13.24	15.6	18.47
ELECTRICAL SUPPLY / power consumption	V/Hz	230/50	230/50	230/50	230/50	230/50	230/50	230/50	230/50	230/50	230/50	230/50	230/50	230/50
MAX. ABSORBED POWER	W	85	85	138	138	138	138	138	138	150	85	138	138	150
PROTECTION DEGREE	IP	X4D	X4D	X5D	X5D	X5D	X5D	X5D	X5D	X5D	X4D	X5D	X5D	X5D
NET WEIGHT	kg	35	35	36	36	36 / 50*	36 / 50*	37 / 51*	37	37	35	37	37	37
GROSS WEIGHT	kg	38	38	39	39	39 / 53*	39 / 53*	40 / 54*	40	40	38	40	40	40

* in cabinet mounting models (Inc)

Unical



Unical AG S.p.A. 46033 casteldario - mantova - italy - tel. +39 0376 57001 - fax +39 0376 660556 - export@unical-ag.com - www.unical.eu

Unical AG declines any liability for the inaccuracies that may appear due to errors in transcription or printing. It also reserves the right to introduce those modifications to its products that it considers necessary or useful, without compromising the essential characteristics of the said products.