

## Condensing Boilers

### UE 2016/426 (Gas Appliance Regulation "GAR")



From the 21 April 2018 is in force the new Gas Appliance Regulation UE 2016/426 for the gas boilers it replace the Gas Appliance Directive 2009/142/CE ("GAD").

The new Regulation introduce the use of additional safety device on the boilers  
Below the modification introduced on the UNICAL Products

#### 1. KONm24 (DUNGS system) from serial N° 18U02867

N° 1 **Air pressure switch NC** (Normally Close) Spare part code : **95002133** on the smoke exhaust pipe (connected in series with the smoke thermostat, error "Tp" on the display in case of intervention)

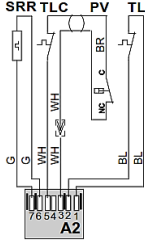
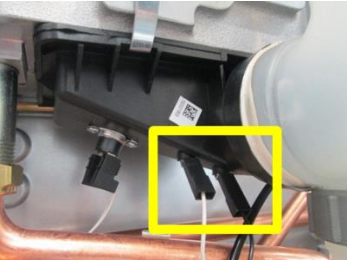
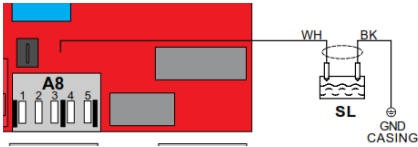



N°1 **Condensing level sensor** on the flue gas collector (lock-out error  in case of intervention)

		<p>PCB Electrical Connection "A2":</p> <p>SRR = CH return NTC Sensor TLC = Flue gas collector limit thermostat <b>PV = Air pressure switch (NEW)</b> TL = Limit thermostat</p>
		<p><b>SL = Condensing level sensor (NEW)</b></p> <p>If SL close = lock-out error </p>

#### 2. KONm 28/35 (SIT System) from S.N° 18U02867/ KON B from S.N° 18U08437 KUTter / KON1 and K+ was made directly under the Regulation "GAR"

For the model **KONm 28/35** is introduced the **SIT PREMIX** system the same used on the KON B/KUTter/KON1/K+  
N°1 Diaphragm on the gas valve (different diameter according the type of gas)

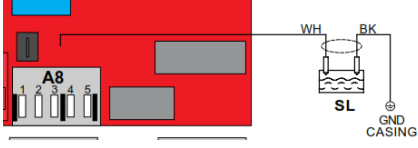
N°1 **Condensing level sensor** on the flue gas collector (lock-out error  in case of intervention)

		 <p><b>SL = Condensing level sensor (NEW)</b></p> <p>If SL close = lock-out error </p>
<p>KON1/K+ 24 kW: <b>G20 - 00253859</b> (Øi. 5,1) <b>LPG - 00253913</b> (Øi. 4,1) All 28/35 kW : <b>G20 - 00253865</b> (Øi. 5,9) <b>LPG - 00253863</b> (Øi. 4,7)</p>		

**IMPORTANT** the NEW PCB 2.0 used in all the version , with the new connection for the SL contact, can be used also in all the previous models for this reason the spare part code is not changed.

### 3. KONE/KONx/OSA

No modification respect to the version produced before the 21 April 2018 - Gas Appliance Regulation UE 2016/426

### 4. ALKON 50/70 from SN° 18U00732 – KON 100/115 from SN° 18U03581 KONf 100/115 form SN° 18U06761

N°2 Air pressure Switch (1 for the Minimum “NO” and 1 for the Maximum “NC”) the two are in series, the PCB need to read at first the contact open , then (after the stert of the fan) close (Min switch in NO position)

N°1 Condensing level sensor on the flue gas collector code **95262464**

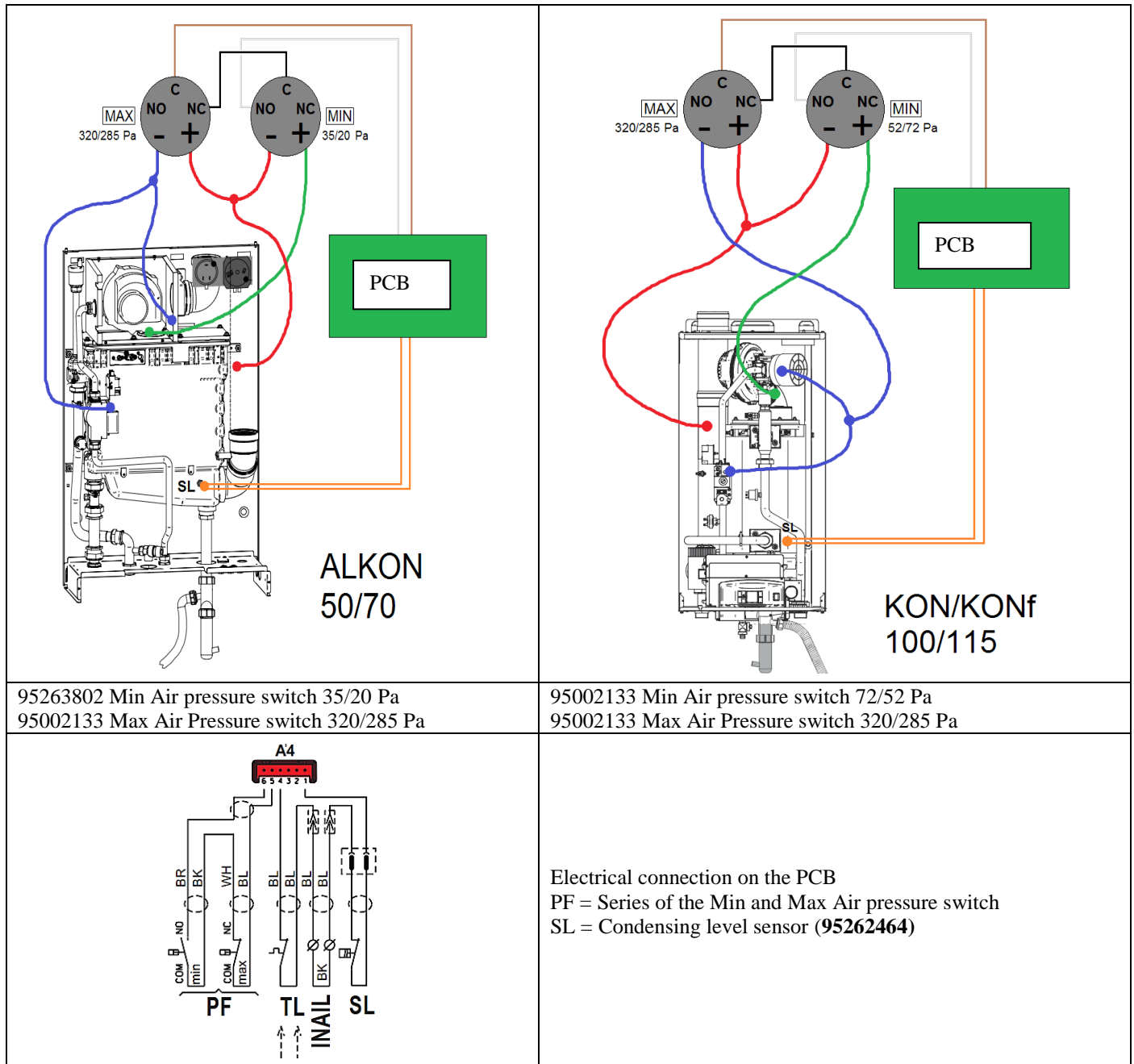

**IMPORTANT** the on this boiler we use a NEW PCB that can be used also on the previous models (before GAR) :

- 95002134 PCB ALKON 70
- 95002135 PCB ALKON 50
- 95002129 PCB KON/KONF
- 95002132 PCB KON/KONF

Errors connected to the new safety devices (visualisation from the boiler display):  
**AS** = the series of the air pressure switches is close before the ignition procedure  
**At** = the series of the air pressure switches do not close during the ignition procedure  
**CO** = the series of the air pressure switches open during the normal working  
**CL** = Condensing level sensor intervention

## 5. ALKON 115/140 from SN° 18U09635

N°3 Air pressure Switch (2 for the Minimum “NO”, one for each module, and 1 for the Maximum “NC”)

N° 2 Condensing level sensor on the flue gas collector

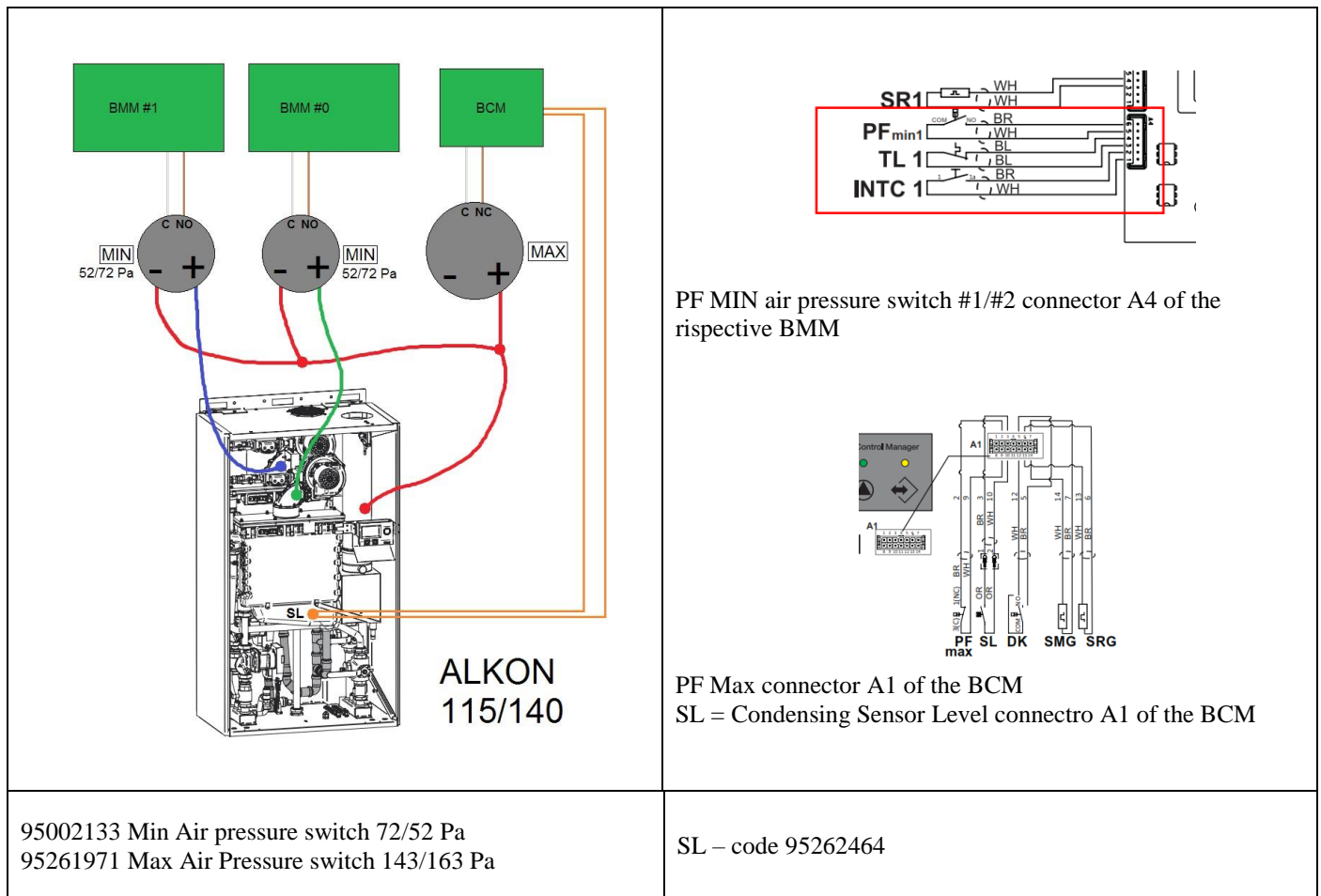

**IMPORTANT** the on this boiler we use a NEW PCB that can be used also on the previous models (before GAR) :

95002184 PCB BMM 2.0 ALKON EXT 140

**Errors connected to the new safety devices, visualisation from the E+ display (HSCP) or UFLY:**

- 22 (BMM#0/1) = Min air pressure swithc #1 or #2 do not **close during** the ignition procedure
- 23 (BMM#0/1) = Min air pressure swithc #1 or #2 **close before** ignition procedure
- 27 (BMM#0/1) = Min air pressure swithc #1 or #2 **open during** the ignition procedure
- 28 (HCM/BMM#0/1) = **Min** air pressure swithc #1 or #2 **or Max** air pressure swithc open during the normal operation
- 29 (HCM) = Condensing level sensor intervention

## 6. MODULEX EXT 100 – 900 from SN° 18U05951

N°2 Air pressure Switch (N°1 for the Minimum “NC” and 1 for the Maximum “NC”)

N°1 Condensing level sensor on the flue gas collector (already present)

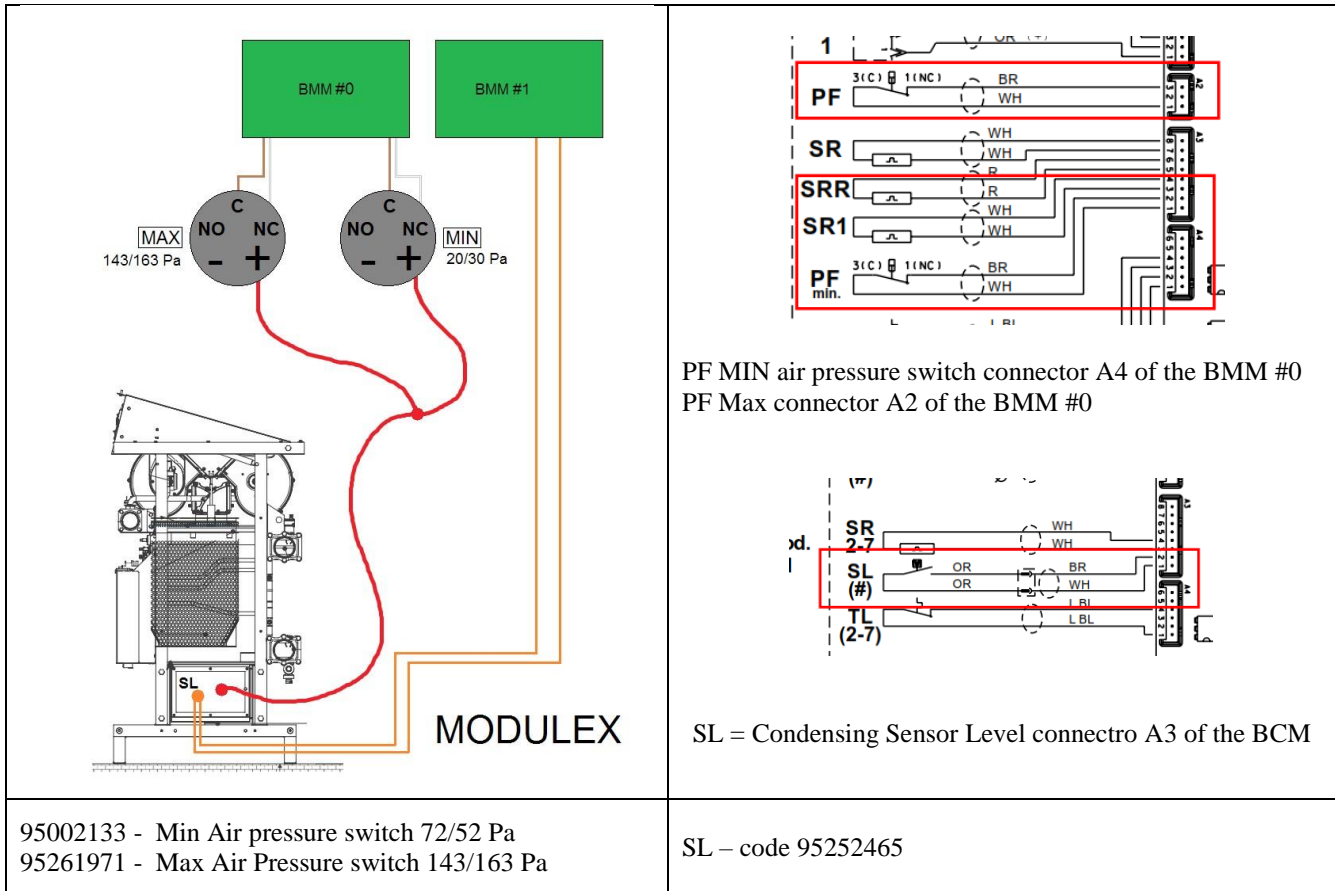

**IMPORTANT** the on this boiler we use a NEW PCB that can be used also on the previous models (before GAR) :

95002126 PCB BMM MDX EXT 100-350

95002127 PCB BMM MDX EXT 440-900

**Errors connected to the new safety devices, visualisation from the E8, E+ (HSCP) or UFLY display :**

**28** = MIN air pressure switch intervention (only with 1 module in function on the minimum power) or MAX air pressure switch intervention (in all the other range of work)

**29** = Condensing level sensor intervention

## 7. SPK115-600 from SN° 18U08593

N°2 Air pressure Switch (N°1 for the Minimum “NC” and 1 for the Maximum “NC”)

N°1 Condensing level sensor on the flue gas collector

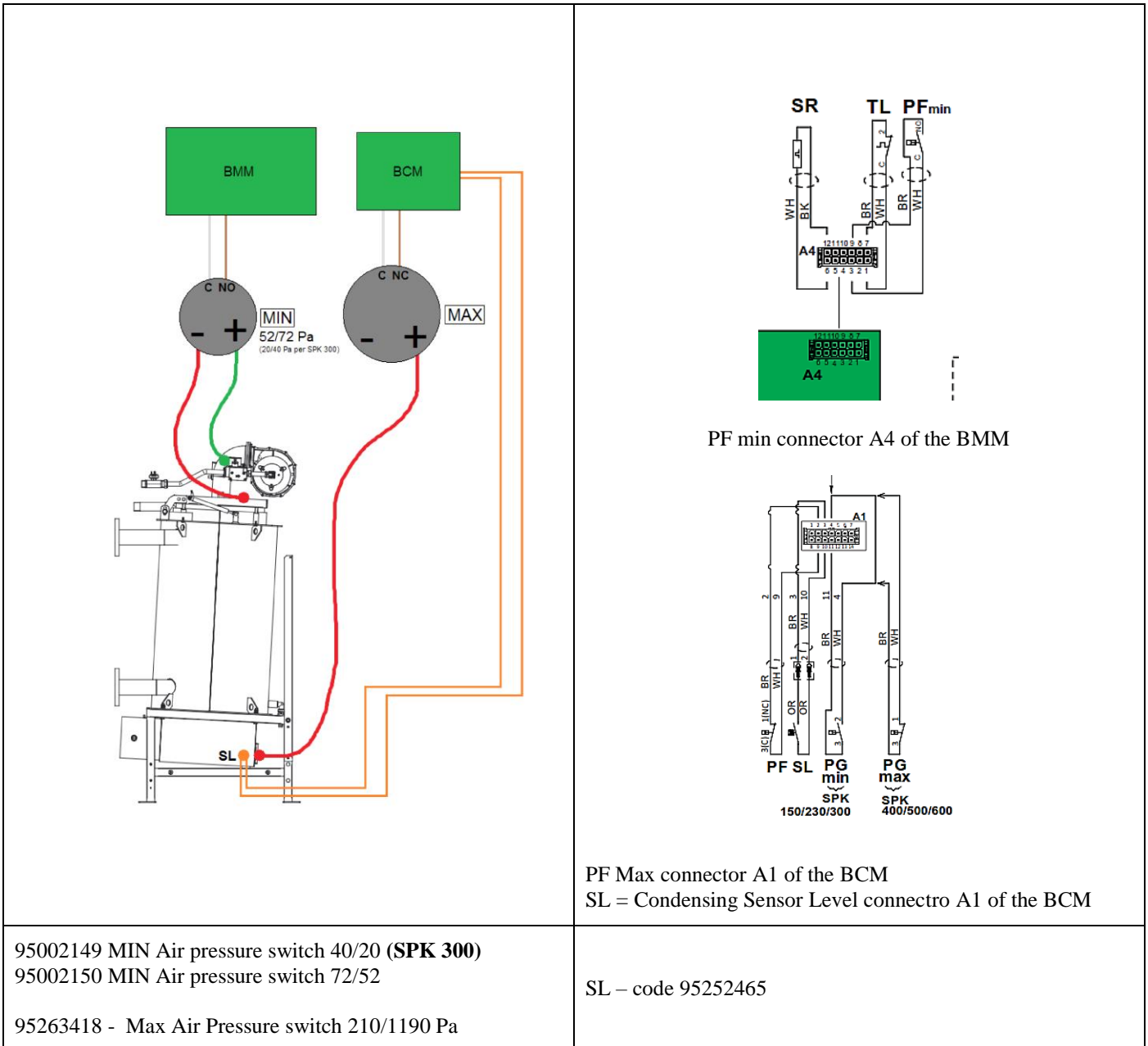

**IMPORTANT** on this boiler we use a NEW PCB that can be used also on the previous models (before GAR) :

- 95002154 PCB BMM SPK 115 2.0
- 95002155 PCB BMM SPK 150 2.0
- 95002156 PCB BMM SPK 230 2.0
- 95002157 PCB BMM SPK 300 2.0
- 95002158 PCB BMM SPK 400 2.0
- 95002159 PCB BMM SPK 500 2.0
- 95002160 PCB BMM SPK 600 2.0

**Errors connected to the new safety devices, visualisation from the E+ display (HSCP) or UFLY:**

- 22 (BMM #0)** = Min air pressure swithc do not **close during** the ignition procedure
- 23 (BMM #0)** = Min air pressure swithc **close before** ignition procedure
- 27 (BMM #0)** = Min air pressure swithc **open during** the ignition procedure
- 28 (HCM)** = **Min** air pressure swithc **or Max** air pressure swithc open during the normal operation
- 29 (HCM)** = Condensing level sensor intervention